

OBSERVABLES IN 3-DIMENSIONAL QUANTUM GRAVITY AND TOPOLOGICAL INVARIANTS

J. Manuel Garcia-Islas

Comunicación Técnica No I-04-03/11-06-2004
(MB/CIMAT)



Observables in 3-dimensional quantum gravity and topological invariants

J. Manuel García-Islas *

Centro de Investigación en Matemáticas
A.P. 402, 36000
Guanajuato, Gto, México
email: islas@cimat.mx

Abstract. In this paper we report some results on the expectation values of a set of observables introduced for 3-dimensional Riemannian quantum gravity with positive cosmological constant, that is, observables in the Turaev-Viro model. Instead of giving a formal description of the observables, we just formulate the paper by examples. This means that we just show how an idea works with particular cases and give a way to compute 'expectation values' in general by a topological procedure.

1 Introduction

The definition of good observables for quantum gravity is one of the most important problems. In this paper we introduce a set of observables in the Turaev-Viro model of 3-dimensional quantum gravity with positive cosmological constant. We also describe a very natural way to define their expectation values. Instead of giving a very formal and rigorous description of these set of observables and of their expectation values we just show how an idea works for some particular examples. The interesting thing is that their expectation value is related to topological invariants of such observables. These observables are thought as graphs, knots or links embedded in a 3-dimensional manifold. When the manifold is S^3 , the examples show us a way to compute this topological invariant for general cases.

We divide this paper as follows: In section 2 we briefly recall the Turaev-Viro model as a spin foam model of 3-dimensional Riemannian quantum gravity

*This paper is based on a part of the Ph.D thesis of the author at the University of Nottingham, UK [1]. The work was motivated by a joint collaboration with John W.Barrett [2].

with positive cosmological constant. In section 3 we introduce the notion of observables in this model as well as their expectation value. In section 4 we apply the introduced concepts of section 3 in order to compute the expectation value of some particular examples. In section 5 we formulate an idea of general observables in the framework of chain-mail decompositions which leads us to compute a topological invariant of knots. We refer to this topological invariant as the chain-mail expectation value of a knotted observable. Moreover, the idea is considered for the particular case of knots embedded in S^3 , We also show its topological invariance as well as give a explicit value of the chain-mail expectation value of a general knot or link in S^3 . Finally in section 6 we give the conclusion and a proposal of future work on the subject.

2 The Turaev-Viro model as a spin foam model of quantum gravity

The Turaev-Viro partition function is an improved regularization of the Ponzano-Regge model [4]. It is a spin foam model of Riemannian quantum gravity with positive cosmological constant. Moreover, the Turaev-Viro sum gives topological invariants of 3-dimensional manifolds M .

Let M be a closed, oriented three dimensional manifold (we can say it is our three dimensional space-time). Take a triangulation Δ of M with n_0 vertices, n_1 edges e_i , n_2 faces f_j and n_3 tetrahedra t_k .

We construct a spin foam model for 3-dimensional Riemannian quantum gravity with positive cosmological constant by using the dual complex \mathcal{J}_Δ to our triangulation Δ of the manifold. ¹ This spin foam construction which uses the dual complex can be found in [5].

In order to construct the model we label each face of the complex \mathcal{J}_Δ by an irreducible representation of the quantum group $SU(2)_q$. The model has an integer parameter $r \geq 3$, from which we define the root of unity $q = A^2 = e^{\frac{2\pi}{r}}$. Since q is a root of unity the number of irreducible representations is finite. A representation can be indexed by a non-negative half-integer j , the spin, from the set $L = \{0, 1/2, 1, \dots, (r-2)/2\}$.

We define a state as a map from the set of faces of the dual complex \mathcal{J}_Δ , to the set L . A state is called admissible if at each edge of the complex \mathcal{J}_Δ , the labels (i, j, k) of the three faces that are adjacent to the edge satisfy

$$0 \leq i, j, k \leq \frac{r-2}{2}$$

¹The description of the Turaev-Viro model by using the triangulation of the manifold is an equivalent one and it is the one we will use for the description of our observables. The triangulation description is found in [6].

$$i \leq j + k, \quad j \leq i + k, \quad k \leq i + j$$

$$i + j + k \equiv \text{mod } 1$$

$$i + j + k \leq (r - 2)$$

The state sum model is then given by

$$Z(M) = N^{-n_0} \sum_S \prod_f A(f) \prod_e A(e) \prod_v A(v) \quad (1)$$

where the sum is carried over the set of all admissible states S and $A(f)$, $A(e)$, $A(v)$ are the face, edge, and vertex amplitudes respectively and N is a normalisation factor which we describe below.

These amplitudes are given by the evaluation of spin networks such as

$$A(f) = \bullet \text{---} \text{---} \rho$$

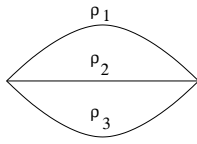
$$A(e) = \frac{1}{\rho_1}$$

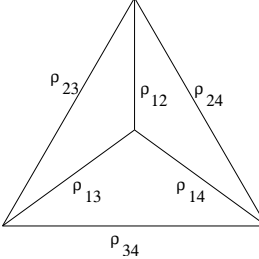
$$A(v) =$$

The evaluation of such spin networks is given by the Kauffman bracket of the respective graph [5].

For instance, the amplitude given to the faces is given by the quantum dimension of the representation, which is given by the formula $\dim_q(j) = (-1)^{2j} [2j + 1]_q$, where $[n]_q$ is the quantum number

$$[n]_q = \frac{q^n - q^{-n}}{q - q^{-1}}$$

The evaluation of the tetrahedron combined with the evaluation of theta symbols gives the so called quantum $6j$ -symbol.

The normalisation factor is given by $N = \sum_{l \in L} \dim_q(l)^2$.

The state sum model is independent from the triangulation of the given manifold M . In terms of the dual complex we can pass from one dual complex to another one by a finite sequence of moves known as Matveev-Piergallini [5].

However the triangulation transformations are simpler and Pachner shows in [7] that any two triangulations of a given 3-dimensional manifold M are related by a sequence of the moves of figure 1 and figure 2.

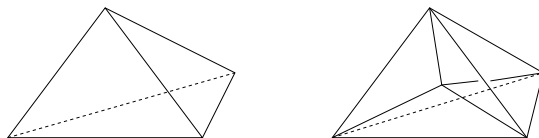

Figure 1: 1-4 Pachner move

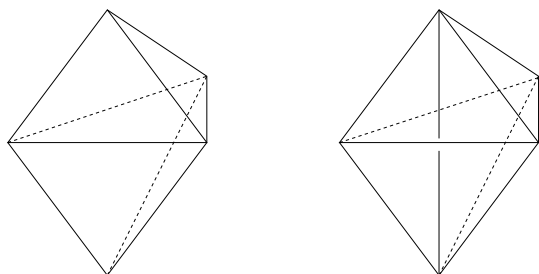

Figure 2: 2-3 Pachner move

The partition function $Z(M)$ is then invariant under the Pachner moves being then an invariant of the 3-dimensional space-time manifold M . It is not difficult to prove that the Turaev-Viro partition function is invariant under the two Pachner moves. The second one follows easily from the Biedenharn-Elliot identity, and the first one follows by a direct calculation.

3 Observables in the Turaev-Viro spin foam model

We now introduce our observables, define its expectation value and compute the expectation value of some particular examples. Our observables are related to graphs contained in the triangulated 3-dimensional manifold M , but these observables are part of the triangulation itself. This will give us invariants of graphs in a 3-dimensional manifold.

A study of different observables for the Turaev-Viro model from ours can be found in [8], [9], [10].

We will consider the triangulation description of the Turaev-Viro model.² Let M be our triangulated 3-dimensional compact space-time manifold

Definition 1 *We define our observables \mathcal{O} to be any subset of interior edges of our triangulated manifold M . We denote them by $\mathcal{O} = (e_1, e_2, \dots, e_n)$. If any of these edges e_i for $i = 1, 2, \dots, n$, intersects the boundary $\partial(M)$, that is, $\partial(M) \cap e_i \neq \emptyset$, then $\partial(M) \cap e_i = v$ for v a vertex of the triangulation.*

Given our observable subset \mathcal{O} , we label its edges by irreducible representations of our quantum group $SU(2)_q$. If $\mathcal{O} = (e_1, e_2, \dots, e_n)$ is our observable with edges e_1, e_2, \dots, e_n , we denote the labelling of its edges by j_1, j_2, \dots, j_n respectively.

Consider now the same partition function of Turaev-Viro with the only difference that we sum over all admissible states for our triangulation Δ except that now we keep the labelling of our observable edges fixed.

We denote this sum as

$$Z(M, \Delta, \mathcal{O})[j_1, j_2, \dots, j_n] = \sum_{S|\mathcal{O}} \prod_f A(f) \prod_e A(e) \prod_v A(v) \quad (2)$$

It is clear that the function (2) is a function of the fixed variables j_1, j_2, \dots, j_n , as well as of the boundary fixed variables. We ignore the boundary fixed variables and concentrate only on the observable fixed variables.

We have that,

$$\sum_{j_1 \in L} \sum_{j_2 \in L} \dots \sum_{j_n \in L} Z(M, \Delta, \mathcal{O})[j_1, j_2, \dots, j_n] = Z(M, \Delta). \quad (3)$$

We state the results in terms of a ‘vacuum expectation value’

$$W(M, \Delta, \mathcal{O})[j_1, j_2, \dots, j_n] = \frac{Z(M, \Delta, \mathcal{O})[j_1, j_2, \dots, j_n]}{Z(M, \Delta)} \quad (4)$$

This sums to 1. The W are of course only defined when $Z \neq 0$. The observable expectation value depends only on the subset of edges and on the representations fixed on its edges. This gives us a way to think of this expectation value as a topological invariant of our graph observable \mathcal{O} . Their physical interpretation is shown with a particular example, and in section 4, a relation to some other field theories such as conformal field theory is found.

Let us consider some examples and see how this idea works. These examples are called the one edge observable, the triangle observable and the square observable.

We will show how the computation of the expectation value works with the one edge observable and just give the final result for the other two cases.

²Now we describe our observables by using the triangulation of our 3-dimensional manifold instead of the dual complex. The idea works anyway in both contexts.

3.1 Examples

The one edge observable

Let \mathcal{O} consists of a single edge e which may intersect the boundary in a single vertex only. That is, at least one vertex of e lies in the interior of M . For this case we prove that

$$W(M, \mathcal{O})[j] = \frac{1}{N} \dim_q(j)^2 \quad (5)$$

where N is the constant defined previously as $N = \sum_i \dim_q(i)^2$.

Note first that clearly these numbers sum to one when we vary j , and are clearly positive. There is then a natural physical interpretation of the above expectation value as the probability that a physical quantity takes the value j [3].

Now, the link of our edge observable is a ball B^3 . Let us suppose first that \mathcal{O} is inside a tetrahedron, as in the figure 3.

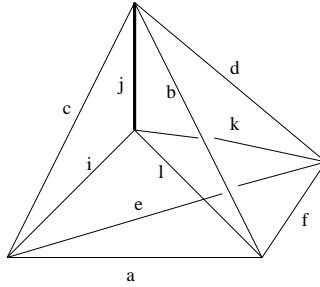

Figure 3: Edge observable inside a tetrahedron

Now, cut this tetrahedron out of the 3-dimensional manifold and consider it as a 3-dimensional manifold with boundary. Actually it is the B^3 ball. Take the partition function of this ball B^3 , keeping in mind that it will be a function of the fixed labelled boundary, and of the fixed labelled one edge observable \mathcal{O} . Using the Turaev-Viro partition function with boundary we then have

$$Z(B^3)[j] = N^{-3} \dim_q(a)^{1/2} \dots \dim_q(f)^{1/2} \sum_{i,k,l} \dim_q(i) \dim_q(k) \dim_q(l) \dim_q(j) \times \\ \times \begin{vmatrix} a & b & c \\ j & i & l \end{vmatrix}_q \begin{vmatrix} f & e & a \\ i & l & k \end{vmatrix}_q \begin{vmatrix} d & b & f \\ l & k & j \end{vmatrix}_q \begin{vmatrix} c & e & d \\ k & j & i \end{vmatrix}_q$$

Note that j is being kept fixed.

Summing over k and using the Biedenharn-Elliot identity and the symmetries of the $6j$ symbol we have that³

³The Biedenharn-Elliot identity and the symmetries of the $6j$ -symbol can be found in [5]

$$\begin{aligned} \sum_k \dim_q(k) \begin{vmatrix} f & e & a \\ i & l & k \end{vmatrix}_q \begin{vmatrix} d & b & f \\ l & k & j \end{vmatrix}_q \begin{vmatrix} c & e & d \\ k & j & i \end{vmatrix}_q &= \sum_k \dim_q(k) \begin{vmatrix} a & f & e \\ k & i & l \end{vmatrix}_q \begin{vmatrix} c & e & d \\ k & j & i \end{vmatrix}_q \begin{vmatrix} b & d & f \\ k & l & j \end{vmatrix}_q \\ &= \begin{vmatrix} a & c & b \\ d & f & e \end{vmatrix}_q \begin{vmatrix} a & c & b \\ j & l & i \end{vmatrix}_q = \begin{vmatrix} a & b & c \\ d & e & f \end{vmatrix}_q \begin{vmatrix} a & b & c \\ j & i & l \end{vmatrix}_q \end{aligned}$$

So we can write now

$$\begin{aligned} Z(B^3)[j] &= N^{-3} \dim_q(a)^{1/2} \dots \dim_q(f)^{1/2} \begin{vmatrix} a & b & c \\ d & e & f \end{vmatrix}_q \\ &\quad \times \sum_{i,l} \dim_q(i) \dim_q(l) \dim_q(j) \begin{vmatrix} a & b & c \\ j & i & l \end{vmatrix}_q^2 \end{aligned}$$

Summing over l and using the orthogonality and symmetry properties gives

$$\sum_l \dim_q(l) \begin{vmatrix} a & b & c \\ j & i & l \end{vmatrix}_q \begin{vmatrix} a & b & c \\ j & i & l \end{vmatrix}_q = \sum_l \dim_q(l) \begin{vmatrix} a & i & l \\ j & b & c \end{vmatrix}_q \begin{vmatrix} a & i & l \\ j & b & c \end{vmatrix}_q = \frac{1}{\dim_q(c)}$$

So that

$$\begin{aligned} Z(B^3)[j] &= N^{-3} \dim_q(a)^{1/2} \dots \dim_q(f)^{1/2} \begin{vmatrix} a & b & c \\ d & e & f \end{vmatrix}_q \\ &\quad \times \sum_i \frac{\delta_{ijc}}{\dim_q(c)} \dim_q(i) \dim_q(j) \end{aligned}$$

where $\delta_{ijc} = 1$ if (i, j, c) are admissible and 0 otherwise.

Taking the sum over i

$$\sum_i \delta_{ijc} \dim_q(i) = \dim_q(c) \dim_q(j)$$

finally gives

$$Z(B^3)[j] = N^{-3} \dim_q(a)^{1/2} \dots \dim_q(f)^{1/2} \begin{vmatrix} a & b & c \\ d & e & f \end{vmatrix}_q \dim_q(j)^2$$

Now glue the ball B^3 back into M , so that

$$\begin{aligned} Z(M, \mathcal{O})[j] &= \dim_q(j)^2 \sum_{S, a, b, \dots, f} \dim_q(a) \dots \dim_q(f) \prod_{\text{edges}} \dim_q(i) \\ &\quad \times \begin{vmatrix} a & b & c \\ d & e & f \end{vmatrix}_q \prod_{\text{tetrahedra}} \begin{vmatrix} a' & b' & c' \\ d' & e' & f' \end{vmatrix}_q \end{aligned}$$

where we have a product of the $6j$ symbol assigned to the tetrahedron $\{\{a, b, c\}, \{b, d, f\}, \{c, d, e\}, \{a, e, f\}\}$ with the $6j$ symbols assigned to all the remaining tetrahedra of the 3-manifold.

As we have that

$$W(M, \mathcal{O})[j] = \frac{Z(M, \mathcal{O})[j]}{Z(M)}$$

and in our sum $Z(M, \mathcal{O})[j]$ we have one less vertex than in $Z(M)$, we have that

$$W(M, \mathcal{O})[j] = \frac{1}{N} \dim_q(j)^2$$

as desired.

It can be seen that the expectation value does not depend on how the edge observable lives inside the triangulated manifold. In particular, the link of a vertex can be given by a more complex polyhedron which is just a triangulated 3-ball. (see figure 4)

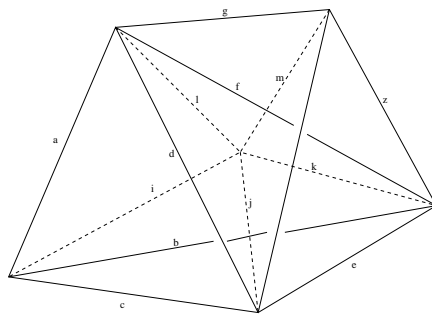

Figure 4: One edge observable inside a polyhedron

The triangle observable

We now consider a triangle observable.⁴ Suppose the manifold M contains a triangle (see figure 5), whose edges form \mathcal{O} , labelled by i , j and c . Let $N_{i,j,c}$ be the dimension of the space of intertwiners, i.e. equal to 1 if the spins are admissible and 0 otherwise. We have that

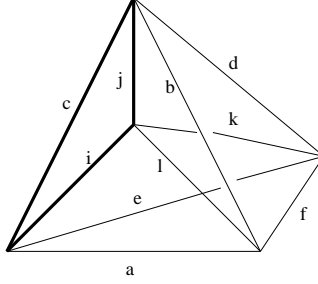

Figure 5: Triangle observable inside a tetrahedron

$$W(M, \mathcal{O})[i, j, c] = \frac{1}{N^2} \dim_q(i) \dim_q(j) \dim_q(c) N_{i,j,c} \quad (6)$$

⁴The computations can be found in [1]

The square observable

Now suppose the manifold M contains a square observable \mathcal{O} whose edges are labelled by the representations i, j, m, n . Then we prove that

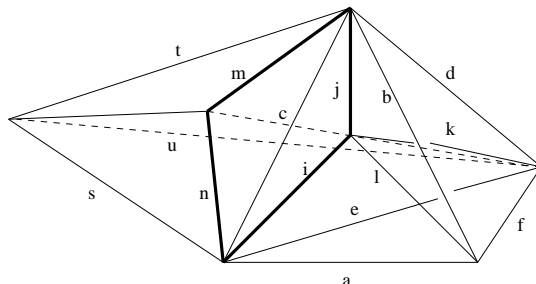

Figure 6: A square observable

$$W(M, \mathcal{O})[i, j, m, n] = \frac{1}{N^3} \dim_q(i) \dim_q(j) \dim_q(m) \dim_q(n) N_{i,j,c} N_{m,n,c} \quad (7)$$

In this section we have shown by examples how to calculate the expectation value of some of our observables. This idea may be extended to more complicated observables and the computational methods are similar. It is really easy to compute the expectation values of observables given by trees, not knotted cycles of any length, and any combination of these examples.

Moreover, we notice that the expectation value of these simple examples do not depend on the manifold in which they are embedded but only in the representations which label them. In general it is the same for trees and not knotted cycles. But what happens if our observable is knotted, or it is link. We think that the above triangulation methods cannot be applied and we require of a more sophisticated method. This is done by the chain-mail method [11]. In the next section we describe a way to deal with knotted observables in the case in which the observable is embedded in S^3 .

4 Knotted observables in S^3 and their chain-mail expectation value

We now describe the idea of knotted observables in S^3 . Following the same strategy of the paper, we just describe the idea a bit informally, but we work on examples to see the way it works.

We define a way to compute their chain-mail expectation value by introducing this picture. The chain-mail expectation value that is described by using

this chain-mail picture is analogous to the expectation value of our observables of the previous chapter and it is restricted to knots and links living in S^3 . A formal description of the relationship of the expectation value of the previous section and of the chain-mail one will appear in [2].

In this section we restrict ourselves and only describe the way to obtain the chain-mail picture of our observable knot or link. We describe how to compute their chain-mail expectation value and then we prove that it is a topological invariant by proving that it remains invariant under the Reidemeister moves. Finally, we give a general formula for the expectation value of any knot or link observable.

Consider a knot or link

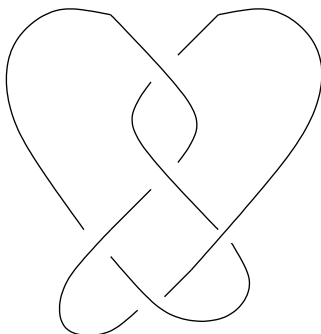

Consider a crossing of our knot observable as shown below,

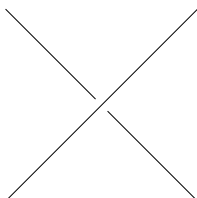

Then to this crossing we assign a diagram as shown below

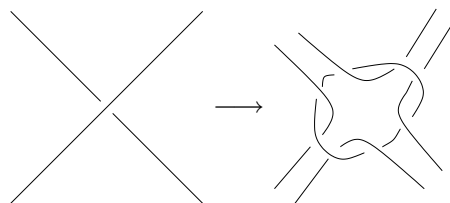

The arrow just denotes this corresponding assignment. Similarly for the opposite crossing. We can proceed with this for every crossing of the knot or link, so that we will have a diagram corresponding to a knot.

For example consider the trefoil knot and take its chain-mail diagram as described. Once all this has been done, we finally add one more circle around each component of the link, so that for the trefoil example, this looks as in figure 7.

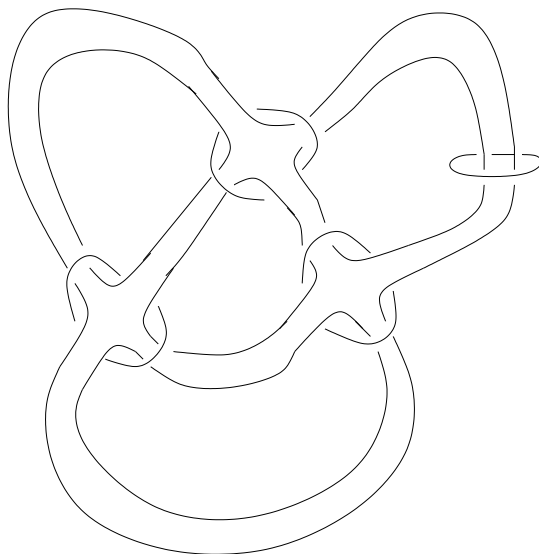

Figure 7:

We call these last circles special ones. This diagram can be thought as a chain-mail diagram and in this way we can define a way to calculate its expectation value.

Definition 2 . Chain-mail expectation value: *Given the described chain-mail representation of our link observable, we define the "chain-mail expectation value" of it as follows: attach $\omega = N^{-1/2} \sum_j^{r-2} \Delta_j \phi_j$ to each strand circle. To the special circles we attach a fixed representation $i \in \{0, \dots, (r-2)/2\}$ of the quantum group. We then evaluate the value $CH(\mathcal{O})$ which is the chain mail value associated to our observable link.*⁵

This expectation value is a topological invariant of our observable. We then prove its invariance under the Reidemeister moves. This tells us that we are in fact dealing with a knot and link invariant.

4.1 Invariance under Reidemeister moves

We prove that the expectation value of our observables is invariant under the Reidemeister moves. In order to prove the invariance under the first and second moves, we simply draw the diagrams and use the known identities of killing an omega, and two-strand fusion respectively. The killing an omega identity tells us that when an ω circle goes around an ω strand component, then the contribution is trivial. The two-strand fusion formula is just the special case

⁵ $\Delta_i = \dim_q j$, and ϕ_j can be thought as the strand component coloured with the j representation (See the appendix, and also [11]).

of the three strand fusion formula explained in the appendix when one of the three strand components that go through the ω circle is labelled by the trivial representation.

Invariance under the first Reidemeister move:

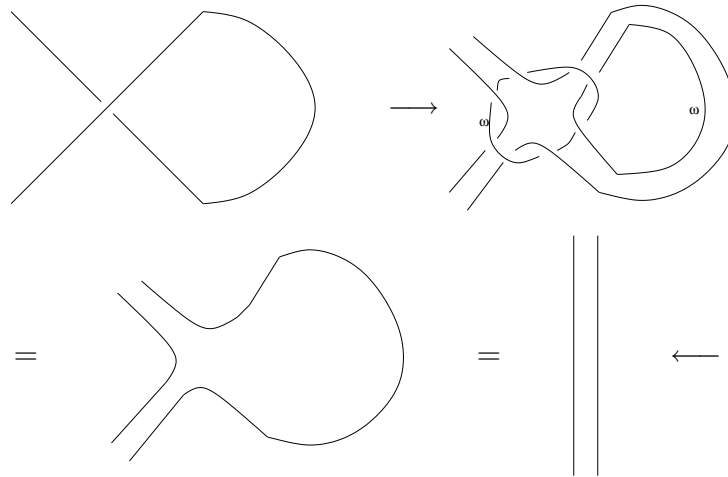

Invariance under the second Reidemeister move:

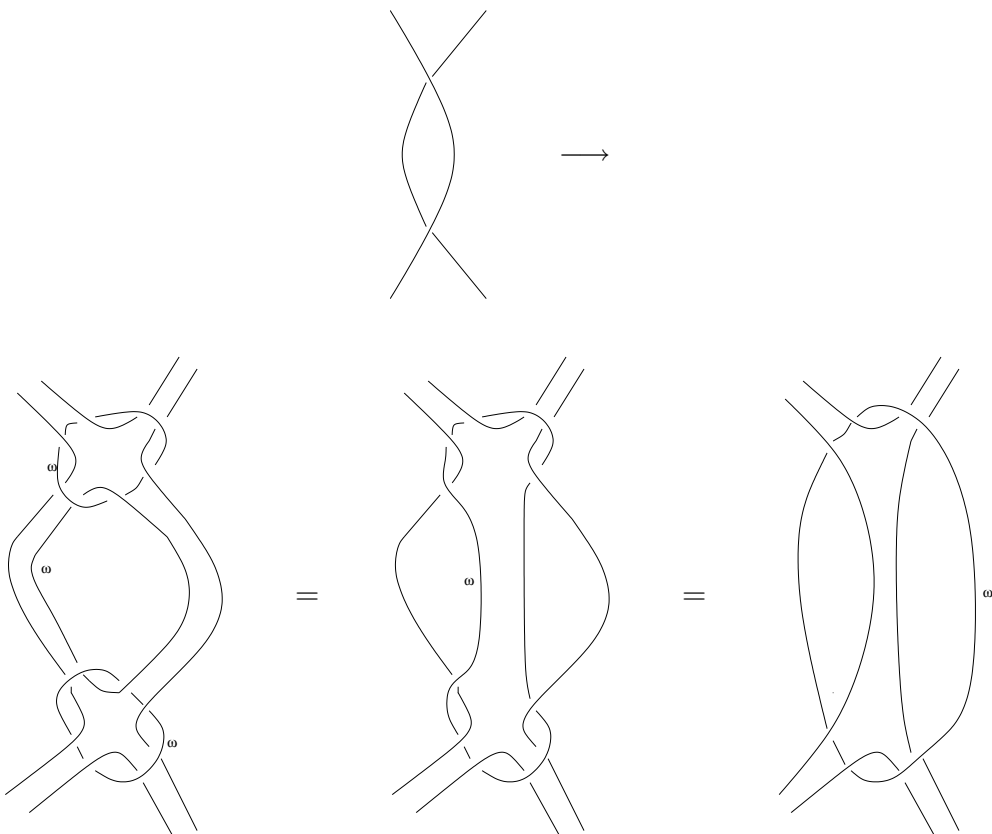

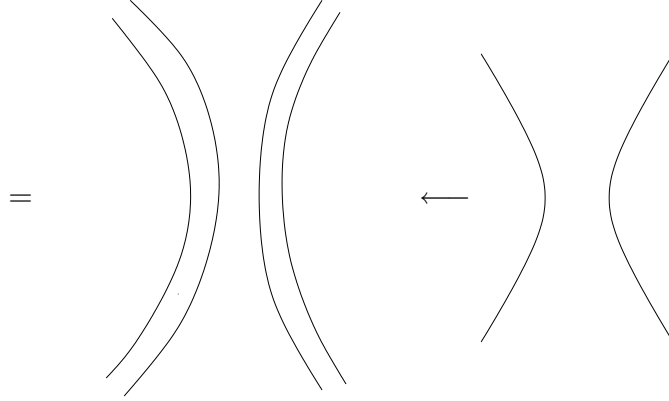

Invariance under the third Reidemeister move cannot easily be computed by the above procedures. To prove the invariance under this move requires the use of the formulas which will be developed in the following section.

4.2 Computing the chain-mail expectation value

We have already studied the chain-mail diagram corresponding to our knot or link observable in S^3 . Moreover, in the whole chain-mail diagram, we have attached $\omega = N^{-1/2} \sum_j^{r-2} \Delta_j \phi_j$ to all the components except to the special circles that go around the chain-mail diagram.

Now, to compute what the expectation value might be for any knot or link observable we use the following fusion strand formulas [1]:

$$\begin{aligned}
 & \text{Diagram 1} = N^{1/2} \sum_{i,j} \frac{\Delta_i \Delta_j}{\theta_{abi} \theta_{cdi} \theta_{bcj} \theta_{adj}} \text{Diagram 2} \quad (8)
 \end{aligned}$$

$$\begin{aligned}
 & \text{Diagram 1} = N^{1/2} \sum_{i,j} \frac{\Delta_i \Delta_j}{\theta_{abi} \theta_{cdi} \theta_{bcj} \theta_{adj}} \text{Diagram 2} \quad (9)
 \end{aligned}$$

These formulas are useful to compute the chain-mail expectation value of any observable. Let us prove the invariance under the third Reidemeister move.

Invariance under the third Reidemeister move:

To prove invariance under this move, one associate to our diagram

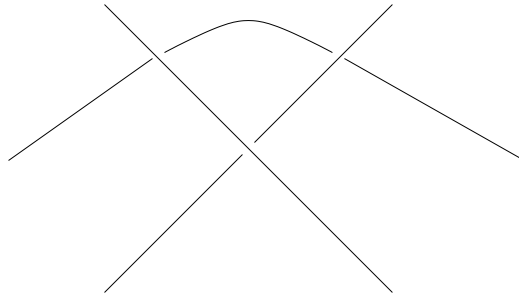

the usual diagram

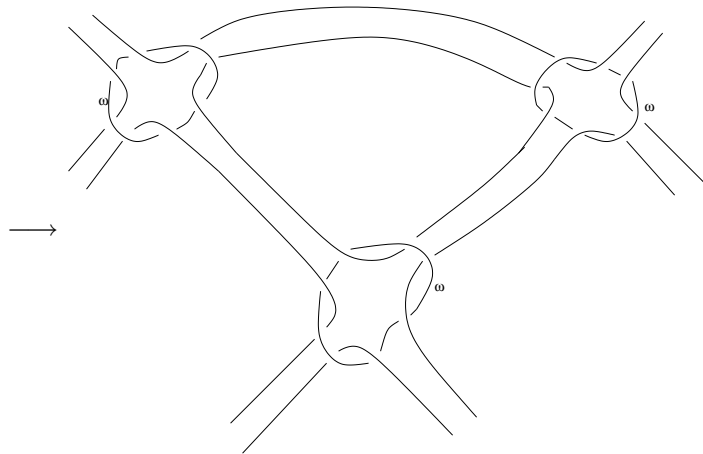

We now apply equations (8) and (9) to the above diagram expanding it in a sum and products of quantum dimensions, theta symbols, quantum 6j-symbols and crossing diagrams. If that is done also for the diagram

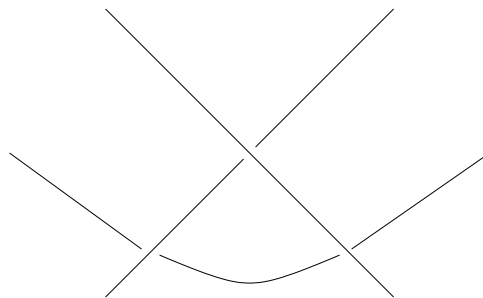

we arrive at two formulas which are equal if

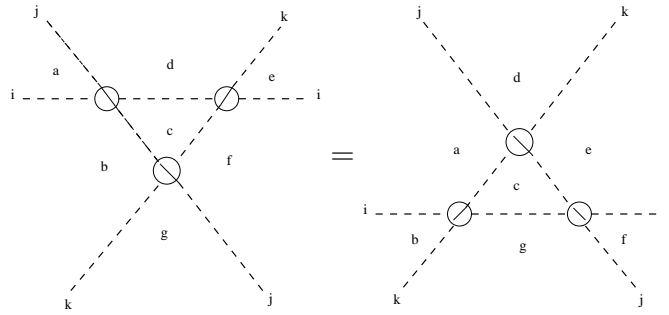

but the above diagram formula is just the equality of two shadow world diagrams. (For a shadow world introduction we refer to [5] chapter 11)

The third Reidemeister move follows.

4.3 Examples

It is now a matter of calculation to work out the chain-mail expectation value of any knot observable by following the above technology. We present the result of the computation two examples. The chain-mail expectation value of our first example was computed step by step in [1]. The second one gives an interesting result where we can see that there might be an interrelation with Conformal Field Theory, as we will explain.

The examples we consider are the trefoil knot and the Hopf link.

The trefoil knot

Consider the trefoil knot

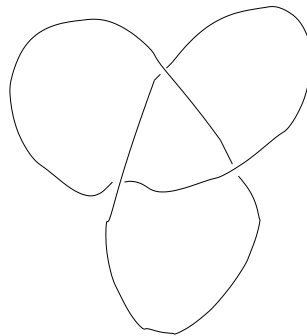

Apply then the above construction to it as follows

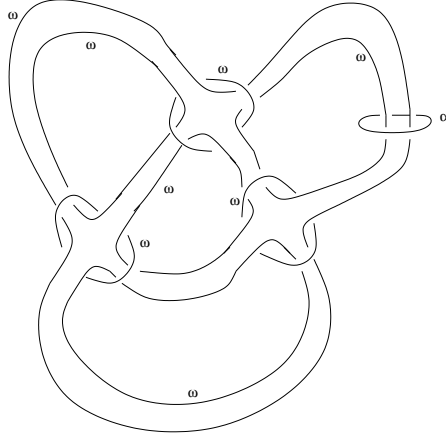

then if we just apply the strand fusion formulas to this chain-mail construction we show that for the trefoil knot

$$CH(S^3, Trefoil)[\alpha] = N^{5/2} \sum_i \frac{S_{i\alpha}}{S_{i0}} \langle Trefoil \rangle_R \quad (10)$$

where $\langle Trefoil \rangle_R$ means the relativistic evaluation given by the coloured Jones polynomial assigned to the trefoil knot times the coloured Jones polynomial assigned to its mirror image [12].

A general formula: In fact it is easy to prove a simple formula which states that given a knot K we have that its chain-mail expectation value is given by

$$CH(S^3, K)[\alpha] = N^{(n/2)+1} \sum_i \frac{S_{i\alpha}}{S_{i0}} \langle K \rangle_R \quad (11)$$

where n is the number of crossings of the knot, and $\langle K \rangle_R$ is its relativistic evaluation given by the coloured Jones polynomial times the coloured Jones polynomial of its mirror image.

More generally, this formula extends to links as follows

$$CH(S^3, L)[\alpha, \beta, \dots, \epsilon] = N^{(\#crossings/2)+1} \sum_{i,j,\dots,k} \frac{S_{i\alpha}}{S_{i0}} \frac{S_{j\beta}}{S_{j0}} \dots \frac{S_{k\epsilon}}{S_{k0}} \langle L(i, j, \dots, k) \rangle_R \quad (12)$$

This general formula follows easily by observing that our fusion formulas (8) and (9) are given by a product of a crossing diagram times a shadow world picture of the opposite crossing of the link. The coefficients which appear in our fusion formulas will be given by the shadow world formula of the complete diagram of our knot or link. We will finally have a product of the coloured Jones polynomial of the knot or link times the coloured Jones polynomial of its

mirror image. Finally, the special circles around each component of our knot or link give rise to the S matrix factors.

The Hopf link

This particular example is of great curiosity as it resembles some very well known formulas of conformal field theory. In particular it makes us think of whether there is a relationship between the chain-mail expectation value of our observables and conformal field theory.

We do not know why this relation appears and it is interesting to search for an explanation which might be hidden in a formulation in terms of the BF theory. Anyway, let us continue and consider the Hopf link

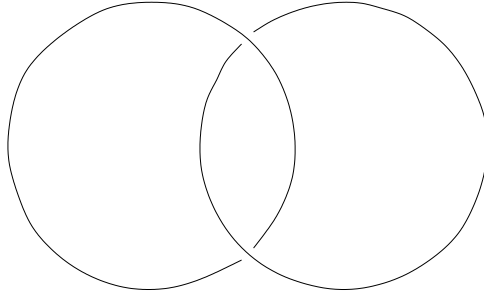

and its diagram

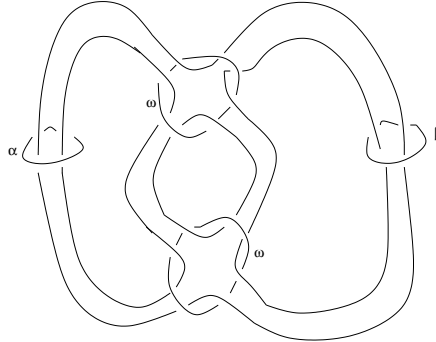

Then its evaluation gives

$$CH(S^3, \mathbf{H})[\alpha, \beta] = \sum_{i,j} \frac{S_{ij}}{S_{00}} \frac{S_{ij}}{S_{00}} \frac{S_{i\alpha}}{S_{i0}} \frac{S_{j\beta}}{S_{j0}}$$

Summing first over the index i we have the relation

$$CH(S^3, \mathbf{H})[\alpha, \beta] = \frac{1}{S_{00}^2} \sum_j \frac{S_{j\beta}}{S_{j0}} \sum_i \frac{S_{ij} S_{ij} S_{i\alpha}}{S_{i0}}$$

If in the spirit of the Verlinde formula, we introduce the abbreviation $N_{\alpha j}^j$ for the sum over i we obtain

$$\begin{aligned}
CH(S^3, \mathbf{H})[\alpha, \beta] &= \frac{1}{S_{00}^2} \sum_j \frac{S_{j\beta}}{S_{j0}} N_{\alpha j}^j \\
&= \frac{1}{S_{00}^2} \sum_j \frac{S_{j\alpha}}{S_{j0}} N_{\beta j}^j
\end{aligned}$$

If we had summed over the j index first, we would have got a similar formula. Both formulas are the same and diagrammatically they may be written as

This identity is an interesting example of an interrelationship between TQFT and conformal field theory, as it is a general case of two well known formulas of conformal field theory.

Let us say for instance that α or β is trivial, then we have that

$$\begin{aligned}
CH(S^3, \mathbf{H})[\alpha] &= \frac{1}{S_{00}^2} \sum_j N_{\alpha j}^j \\
&= \frac{1}{S_{00}^2} \sum_j \frac{S_{j\alpha}}{S_{j0}}
\end{aligned}
\tag{14}$$

which diagrammatically can be expressed as

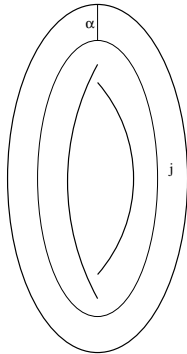

This last formula is the dimension of the torus with one point charge of conformal field theory. ⁶

Now, if both α and β are trivial, then we have

$$CH(S^3, \mathbf{H}) = \frac{1}{S_{00}^2} \sum_j \delta_j^j = \frac{1}{S_{00}^2} \dim \mathbf{T} \quad (15)$$

which is the dimension of the torus with no point charges on its boundary, which is another well known fact of conformal field theory.

5 Conclusions

In this paper we presented a set of observables for 3-dimensional Riemannian quantum gravity with positive cosmological constant which also give topological invariants of graphs embedded in 3-dimensional manifolds. For the case of knots and links, we just dealt with the case of S^3 . Although the treatment of the topological invariance of the knots and links observables embedded in any 3-dimensional manifold will appear in [2], a way to compute the expectation values by following an analogue procedure to the one we gave will be interesting to describe.

These observables have been described in the discrete version of quantum gravity, and it is interesting to find a description of these observables in terms of BF theory.

The treatment given here could shed some light in finding a set of observables for more interesting and physically relevant spin foam models. We can mention that at least for other topological field theories there is a generalisation; for instance we can describe the same kind of observables for the Crane-Yetter model.

⁶It is important to notice here that the dimension of the torus with one point charge, and the dimension of the torus with no point charges are to be understood in the context of conformal field theory, and not to be confused with its dimension as a Riemann surface.

A Chain-Mail Invariants of 3-dimensional Manifolds

In this appendix we introduce the chain-mail invariants of 3-dimensional manifolds which were introduced by Roberts [11]. This picture is a description of the 3-manifold as a special link formed by the attaching curves of the handle decomposition of M . The relation to the Turaev-Viro model described in the previous chapter will be developed. We consider again M to be a closed, connected oriented 3-dimensional manifold as in the previous chapter.

Definition 3 *Let D be a handle decomposition of M with d_0, d_1, d_2, d_3 handles of the corresponding dimensions. Let H be the union of the 0- and 1- handles, and H' be its handlebody complement, i.e. 2- and 3-handles. Drawing the attaching curves of the 2-handles in ∂H and then pushing them slightly into H then adding the meridians of the 1-handles linking them locally in H and finally giving framings to all these curves, produces a kind of link which is called a chain – mail link denoted as $C(M, D) \subseteq H$.*

An example of how it would look appears in figure 8

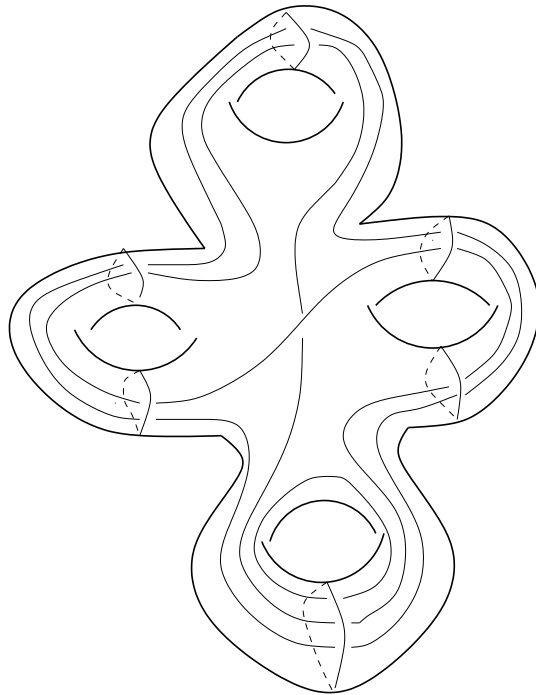

Figure 8: Chain-Mail link

The next step is to embed our handle-body H in S^3 so that we have a link. If we write E for our embedding and $C(M, D, E)$ for the image of $C(M, D)$

on S^3 , we can now attach ω to all of its components, and not forgetting about the framings, we obtain an element of \mathbf{C} by applying the fusion rules to it as before. Multiply now this element by $N^{-d_0-d_3}$ and denote this last value as $CH(M, D, E)$.

In [11] it was shown that the value $CH(M, D, E)$ is independent of the embedding so we may just write $CH(M, D)$ for the above value. Moreover, if D_1, D_2 are two handle decompositions of M then $CH(M, D_1) = CH(M, D_2)$.

Now we describe the relation between the chain-mail invariant and the Turaev-Viro model described in the previous chapter.

Let T be a triangulation of our 3-dimensional manifold M , and consider its dual complex which is formed by placing a vertex inside each tetrahedron, and one edge intersecting each triangle as shown for a tetrahedron in the figure below. We use arrows just to distinguish it from the other edges of the tetrahedron.

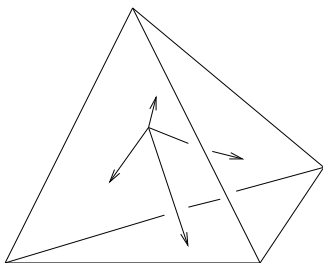

Figure 9: Dual complex

The next step, is to thicken the dual complex of our triangulation and add curves δ_j corresponding to the face f_j , and curves ϵ_i corresponding to the edges e_i , so that we end up with a chain mail D^* which looks like figure B.3, for each tetrahedron.

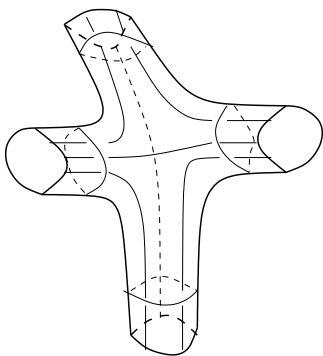

Figure 10: Chain-mail picture of a tetrahedron

The relation between the Turaev-Viro partition function and the Chain-mail picture is understood in the following theorem which is proved in [11].

Theorem 1 *The chain-mail invariant of M $CH(M, D^*)$ equals the Turaev-Viro invariant $Z(M)$.*

The idea of the proof is to embed the chain-mail D^* which we constructed from the triangulation into S^3 substituting ω along all the attaching 2-handles and then use the 3-strand fusion formula defined by

$$\begin{array}{c} i \quad j \quad k \\ | \quad | \quad | \\ \text{---} \text{---} \text{---} \\ | \quad | \quad | \\ \Omega \end{array} = \frac{N^{1/2}}{\theta_{ijk}} \begin{array}{c} i \quad j \quad k \\ \diagdown \quad | \quad \diagup \\ \text{---} \text{---} \text{---} \\ \diagup \quad | \quad \diagdown \\ i \quad j \quad k \end{array}$$

along all the δ curves (which correspond to faces of the triangulation).

The result will be a sum over all labellings of the 2-handles, of a product of Δ_i coefficients associated to 2-handles, trihedron coefficients associated to 1-handles, and tetrahedron coefficients associated to the 0-handles. This final sum after some careful observation equals the Turaev-Viro state sum, obtaining then the equality $CH(M, T) = Z(M)$, and showing that the Turaev-Viro partition function is equivalent to the Chain-Mail invariant of a 3-dimensional manifold.

We are then in a position to use them interchangeably selecting the most appropriate one to our needs.

References

- [1] J. Manuel García-Islas 2003 Aspects of (2+1)-dimensional quantum gravity and topology, Ph.D Thesis, University of Nottingham, UK.
- [2] John W.Barrett and J.Manuel García-Islas, Observables in the Turaev-Viro model, (In preparation)
- [3] John W.Barrett 2003 Geometrical measurements in 3-dimensional quantum gravity, Int.J.Mod.Phys **A18S**, 97-113 gr-qc/0203018
- [4] G.Ponzano, T.Regge 1968 Semiclassical Limit of Racah Coefficients, Spectroscopic and group theoretical methods in physics, 1-58.
- [5] L.H.Kauffman, S.L.Lins 1994 Temperley-Lieb Recoupling Theory and Invariants of 3-Manifolds, Princeton University Press.
- [6] V.G.Turaev, O.Y.Viro 1992 State Sum Invariants of 3-Manifolds and Quantum 6j-Symbols, Topology. **31** No 4, 865-902.
- [7] Pachner.U 1991 PL homeomorphic manifolds are equivalent by elementary shelling, Europ.J.Combinatorics **12**, 129-145.
- [8] F.Archer, R.M.Williams 1991 The Turaev-Viro State Sum Model and Three-Dimensional Quantum Gravity, Physics Letters B. **273**, 438-444.
- [9] A.Beliakova, B.Durhuus 1995 Topological Quantum Field Theory and Invariants of Graphs for Quantum Groups, Communications in Mathematical Physics **167**, 395, hep-th/9309024
- [10] M.Karowski, R.Schrader 1993 A combinatorial Approach to Topological Quantum Field Theories and Invariants of Graphs, Communications in Mathematical Physics **151**, 355-402.
- [11] J.Roberts 1995 Skein Theory and Turaev-Viro Invariants, Topology. **34** No 4, 771-787.
- [12] John W.Barrett 1998, The Classical Evaluation of Relativistic Spin Networks, Adv.Theor.Math.Phys **2**, 593-600, math.QA/9803063